

Varenummer: 203180M16125C3T  
 Beskrivelse: E+G Justerfod  
 GN 31-80-M16-125-C3-T  
 Note: T Uden møtrik, spændeflade i bunden

## Mål

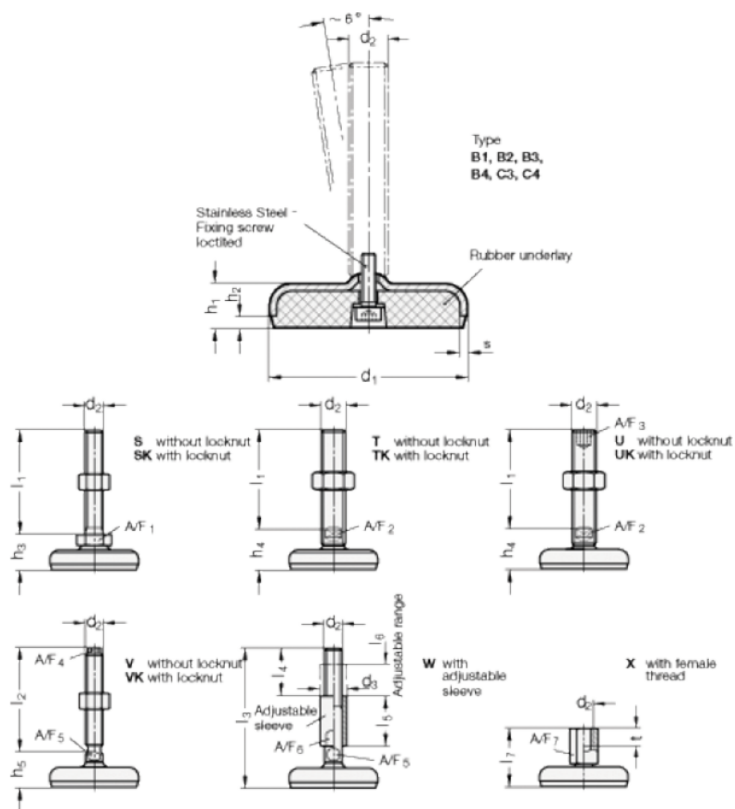

A/F2	=	12
d1	=	80
d2	=	16
h1	=	18
h2	=	5
h4 +4.0/0	=	32
l1	=	125
s	=	3